

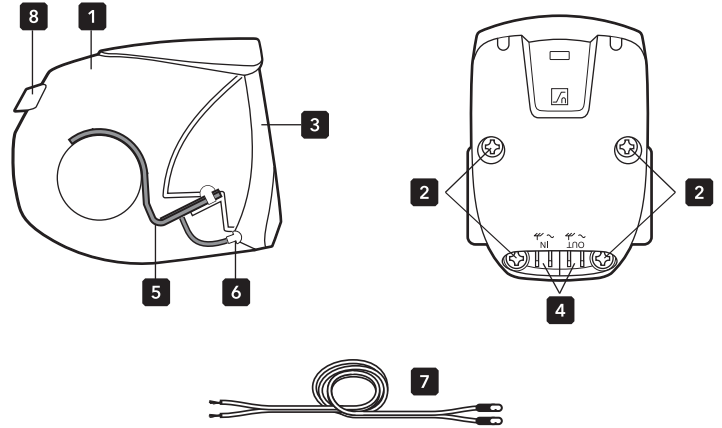

Parts

1. Cover
2. Clamp Bolts
3. Lens with Clarity™ Optics
4. Connection Terminals
5. CryoCore™ Connector
6. Standlight LEDs
7. Dynamo Cable
8. On/Off Switch

▲ Hub Dynamo, Dynamo Plug and Rear Light not included

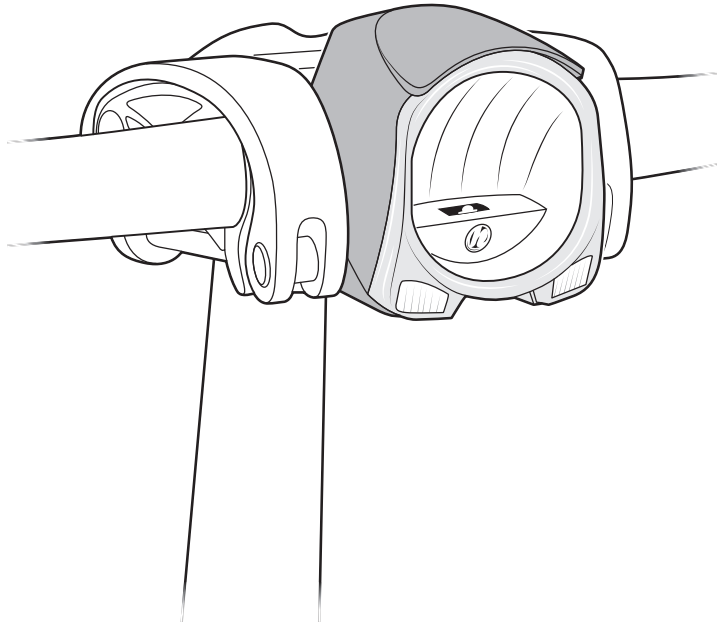

Valo™ 2

Tools Required (not supplied)

No.2 Crosshead Screwdriver

Usage and Service

The electronics are maintenance-free and lamp parts do not need servicing or replacing. The electronics are protected against over-voltage from the dynamo, even when no rear light is connected.

- ▲ The Valo 2 can only be used with hub dynamos (AC). Do not connect to direct current, such as batteries and other DC power supplies, including ebikes.
- ▲ To prevent vision impairment, never look directly at the light.
- ▲ Before riding, always ensure your light is clean, functioning correctly and that you are visible to other road users.
- ▲ To clean, wipe the Lens and Cover with a damp cloth using mild detergent. Do not use solvents or alcohol.
- ▲ The Valo 2 has been designed for outdoor usage and can be used in heavy rain and snow. Do not submerge in water.
- ▲ The light may flicker at low speeds as the light attempts to use as much energy as possible.

Compatibility

The Valo 2 fits handlebars that use the Andros™ adjustable stem as well as those using the Syntace VRO 47.

Installation

1. Remove Grip, Brake Lever, and Gear Shifter from one side of the Handlebar.

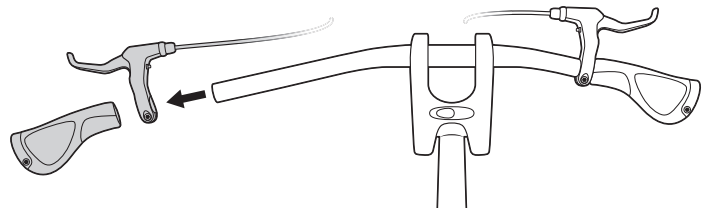

2. Loosen the Stem and slide the Handlebar halfway out. Remove Valo if fitted.

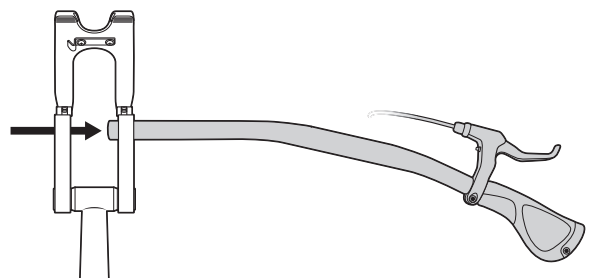

3. Position the Valo 2 within the Stem and slide Handlebar through the Clamp Hole.

▲ If the Handlebar doesn't fit through the Clamp Hole, loosen the four Clamp Bolts evenly and try again.

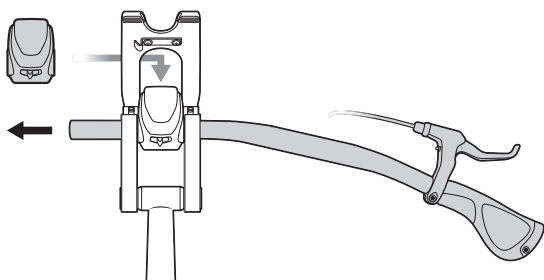

4. Tighten the Stem and install the Grip, Brake Lever, and Gear Shifter, tightening all to manufacturer specifications.

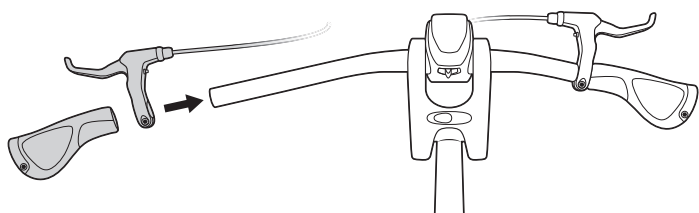

7. Switch on the Valo 2 and adjust the angle according to the area you want lit up.

▲ We recommend angling the central beam approximately 10 m in front of the bicycle.

▲ If the Valo 2 cannot rotate, evenly loosen the Clamp Bolts a quarter turn.

▲ Ensure the beam does not shine into on-coming traffic.

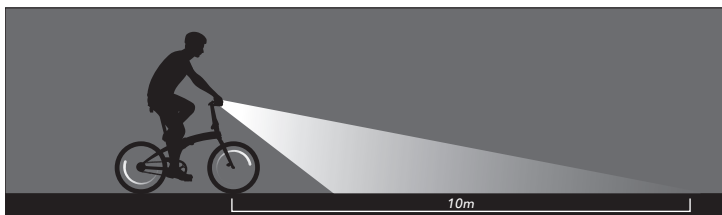

Standlight

A capacitor is charged when moving so that when you're stationary, the power is dissipated through two Standlight LEDs. The capacitor takes about three minutes to reach full charge (depending on speed, wheel size and dynamo power). The Standlight LEDs only function when the Valo 2 is switched on.

Rear Light

The Valo 2 is compatible with conventional rear dynamo lights and allows the On/Off Switch to control both lights. Follow the rear dynamo light manufacturer's directions and connect to the Rear Light Terminals.

▲ Never ground to frame. Always connect both cables to both lights.

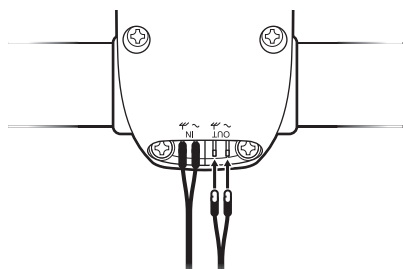

5. Tighten the four Clamp Bolts evenly until the Valo 2 remains in place.

▲ Do not over-tighten the screws, otherwise the plastic casing may break.

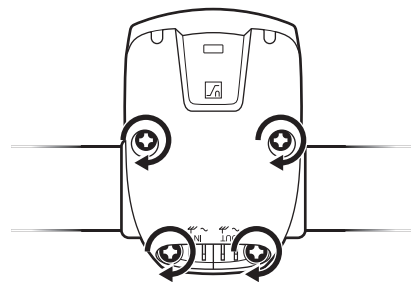

6. Connect the Dynamo Cable to the Dynamo Terminals. There is no polarity so the cables can be installed to either Terminal (+/-).

▲ To prevent rider injury or death, ensure the Dynamo Cable is installed correctly and does not entangle moving parts.

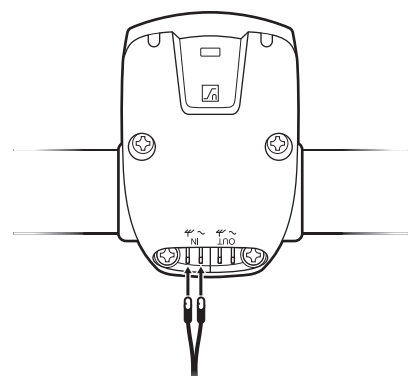

Technology by Herrmans™

Specification

Max. Brightness.....	150 lumen, 40 lux at 10 m
Lens Type	Clarity™ Optics
Illuminant	Philips Luxeon Rebel (white LED)
Illuminant Lifespan.....	50,000 hours
Standlight.....	Two oval (white LED)
Standlight Runtime	4 min (minimum)
Material	Cold-resistant ABS
Dimensions.....	77 x 60 x 63 mm
Weight.....	74 g 2.61 oz
Compatible Handlebar Diameter	25.4 mm (1")
StVZO Compliant	Yes, K1022
Temperature Range.....	-40°C ~ 50°C (-40°F ~ 122°F)

* Included parts and specification subject to change.

Dynamo Hub

The Valo 2 is optimized for usage with both 2.4 W and 3.0 W Dynamo Hubs, but we recommend using the BioLogic Joule™ 3 Dynamo Hub.

Legal and Trademarks

* Tern, the Tern Werd (logotype), the Tern Berd (device), SideLight, CryoCore, Clarity, Joule 3, and BioLogic used alone or in combination are trade names, trade devices or registered trademarks of Mobility Holdings, Ltd.

* Trademarks are the property of their respective owners.